

FootMaster North America

division of DoRodo, LLC

4655 Division Street, Wayland, MI 49348 USA

866-362-3226 phone

www.footmaster.us info@footmaster.us

M16x2.0 TAP

DEPTH MIN 14(9/16")

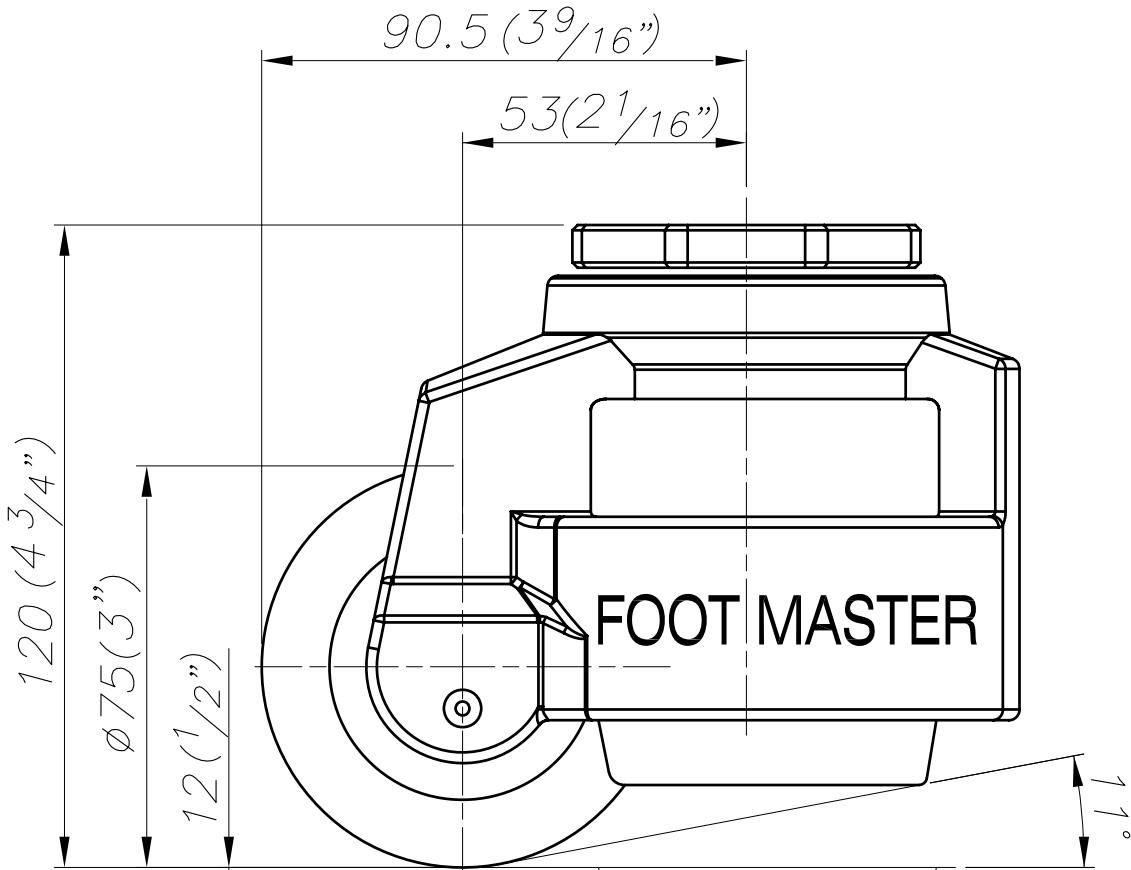
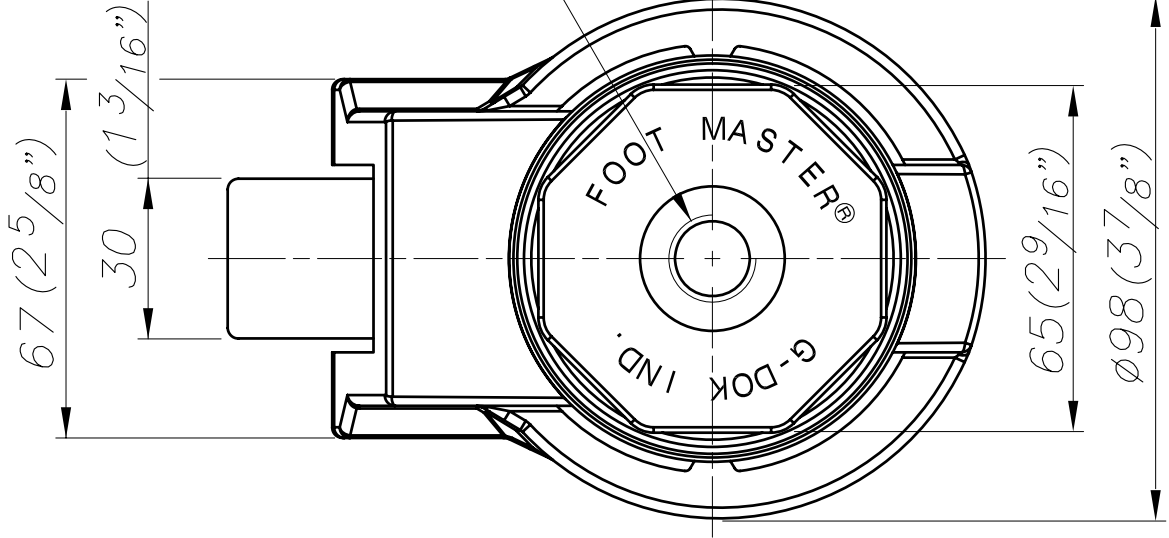

Previously know as
GD-100S

FOOT MASTER ®

FOOMA ®

G-DOK IND.

MODEL NAME

GD-100-S-NYN

A

B

C

E

F

G